

3 SEATER ROUND two parts

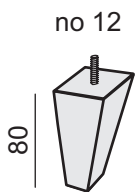

A1 x6

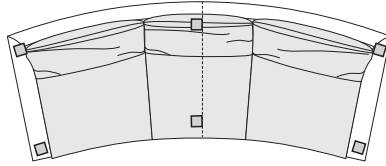

1

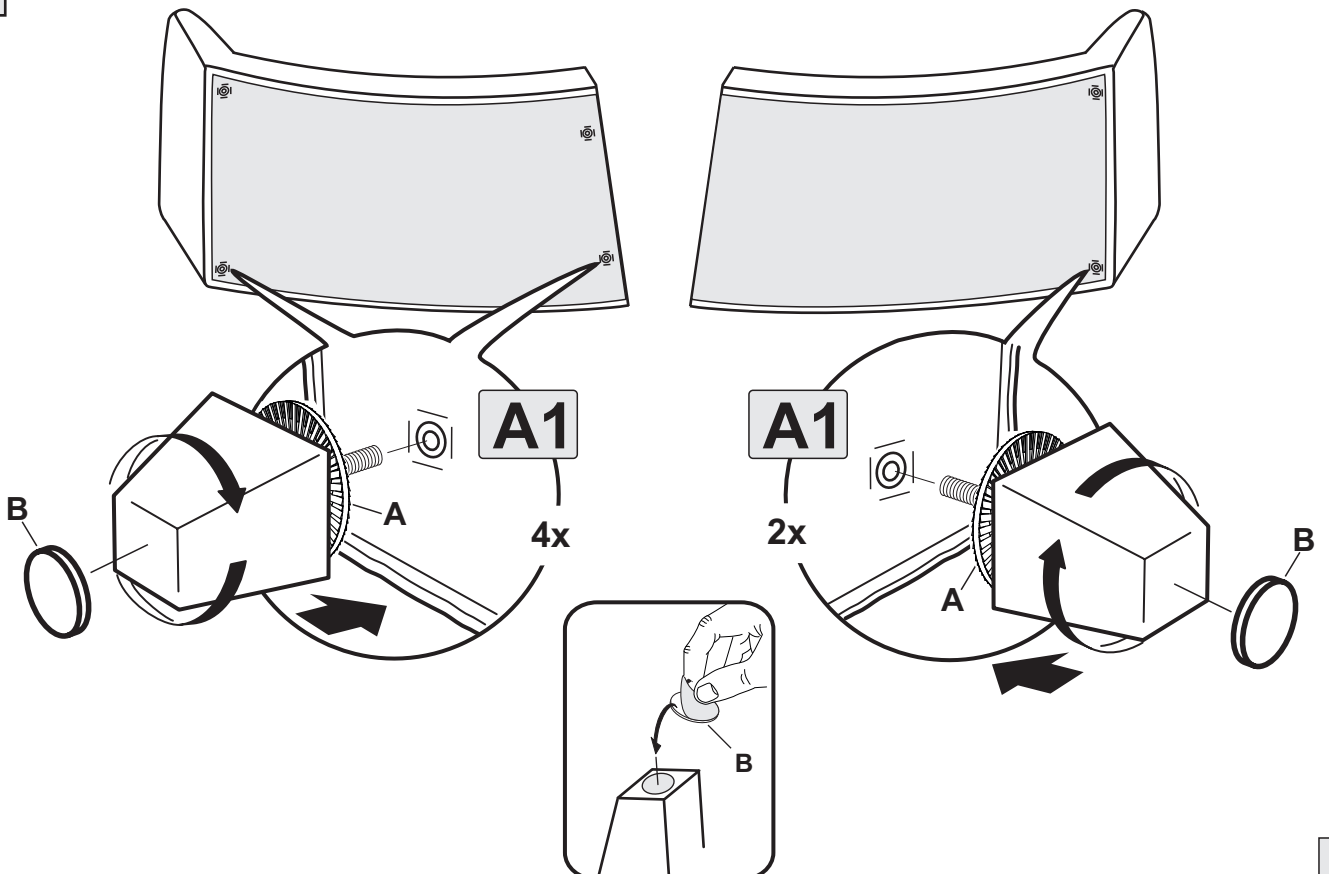

2

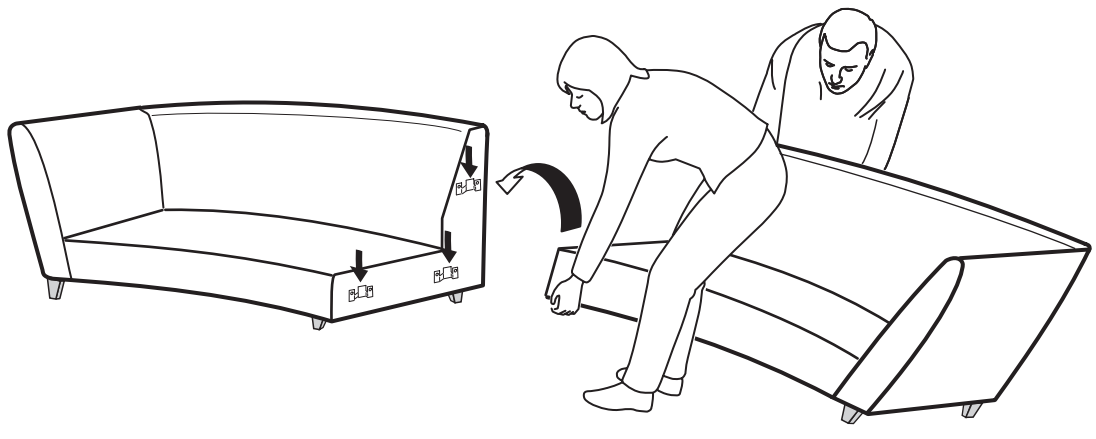

3 SEATER two parts

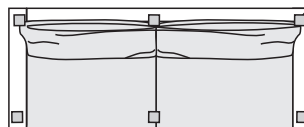
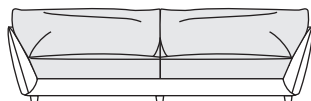

no 12

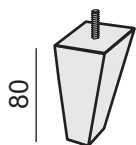

A1 x6

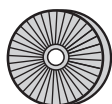

φ45x3

A x6



φ37x3

B x6



M8x60

C x3



8,5x22

D x3

3

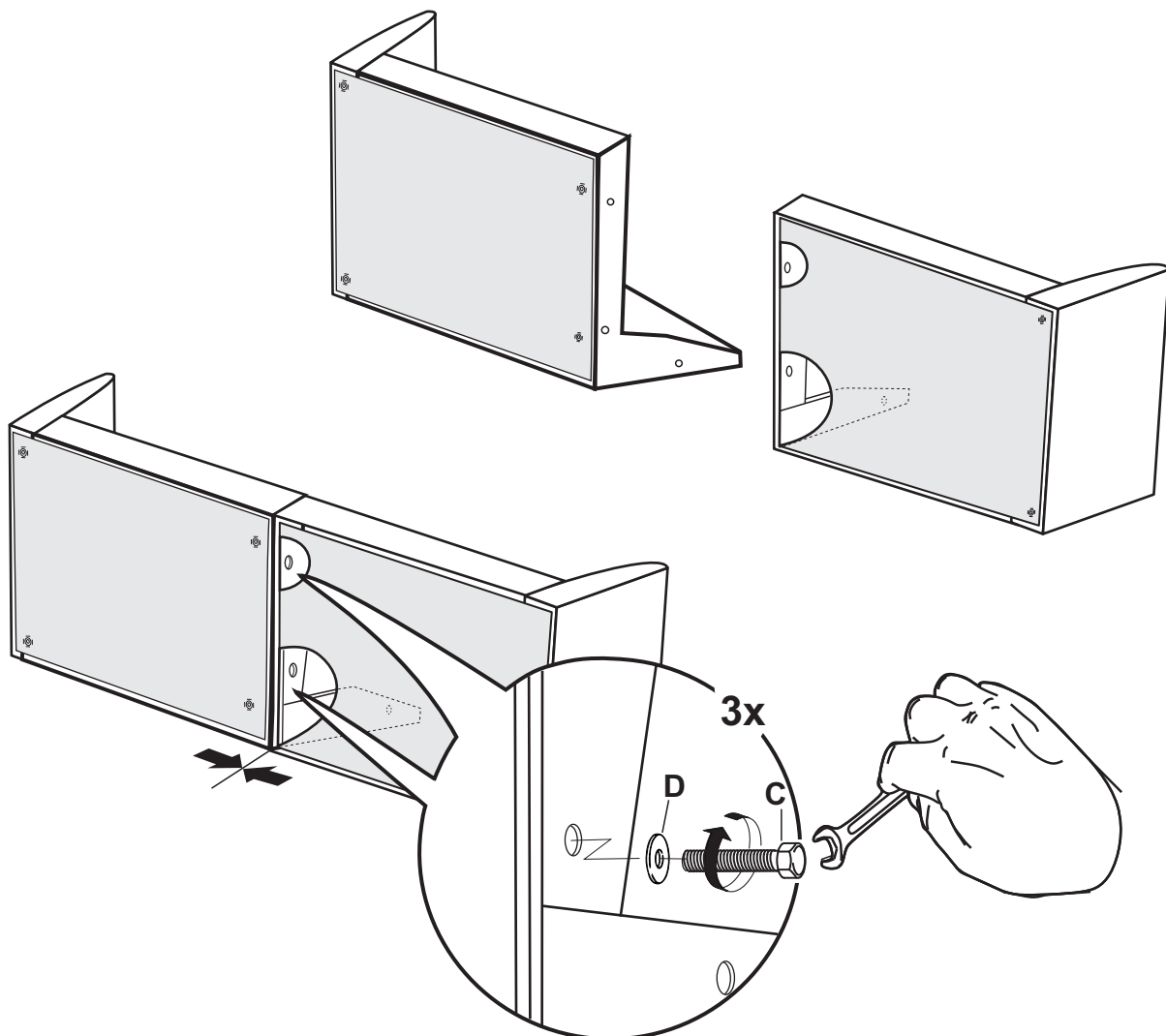

2

4

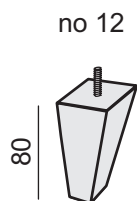
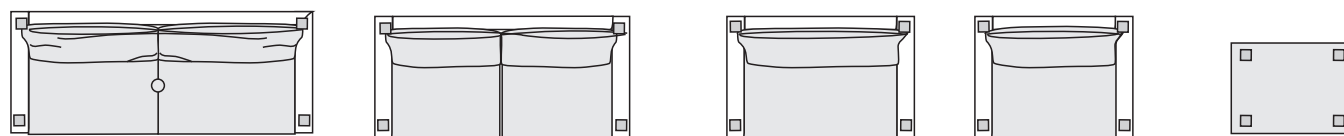
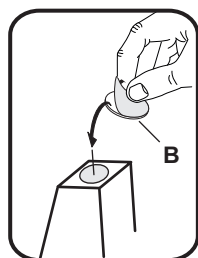
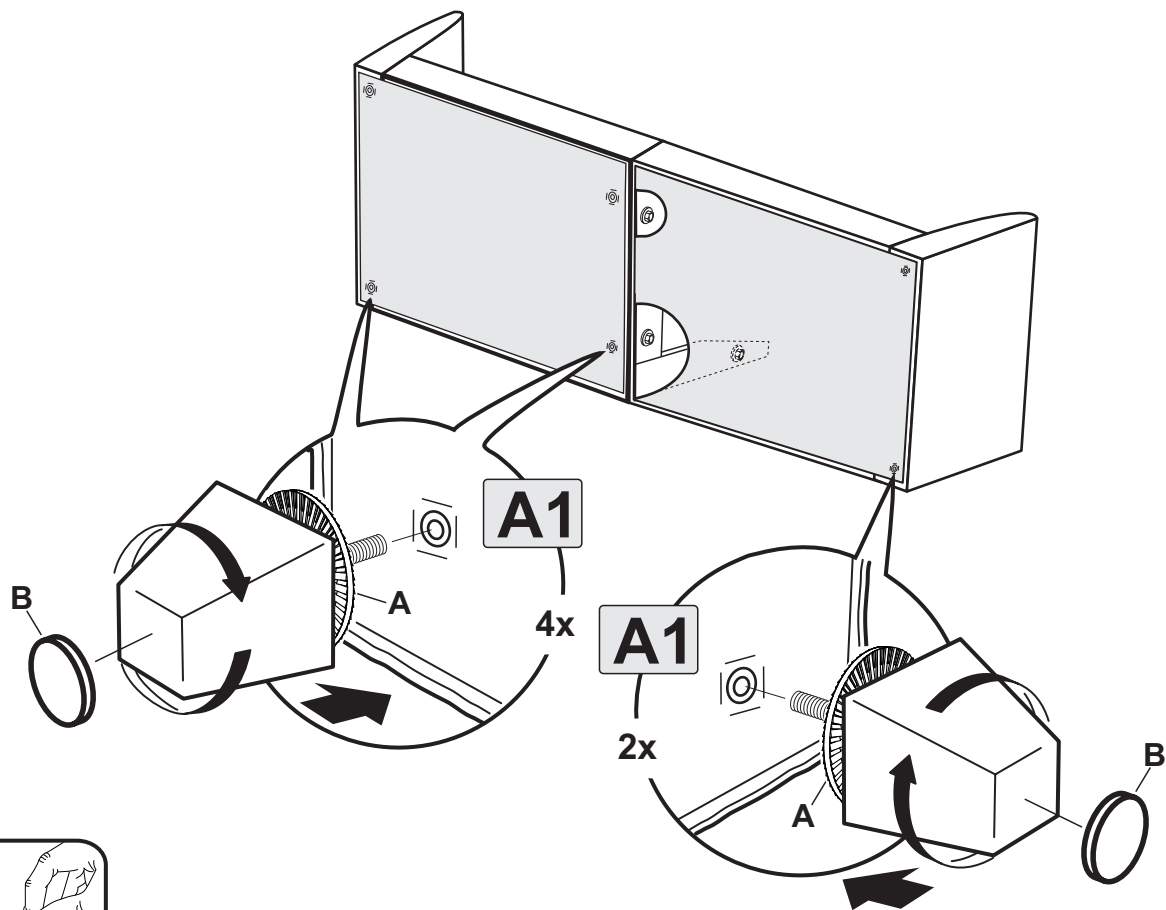

A1 x4

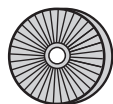

$\phi 45 \times 3$
A x4



$\phi 37 \times 3$
B x4

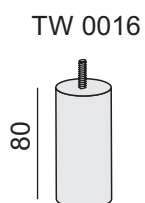

B1 x1



$\phi 45 \times 3$
A x1



$\phi 37 \times 3$
B x1

3

5

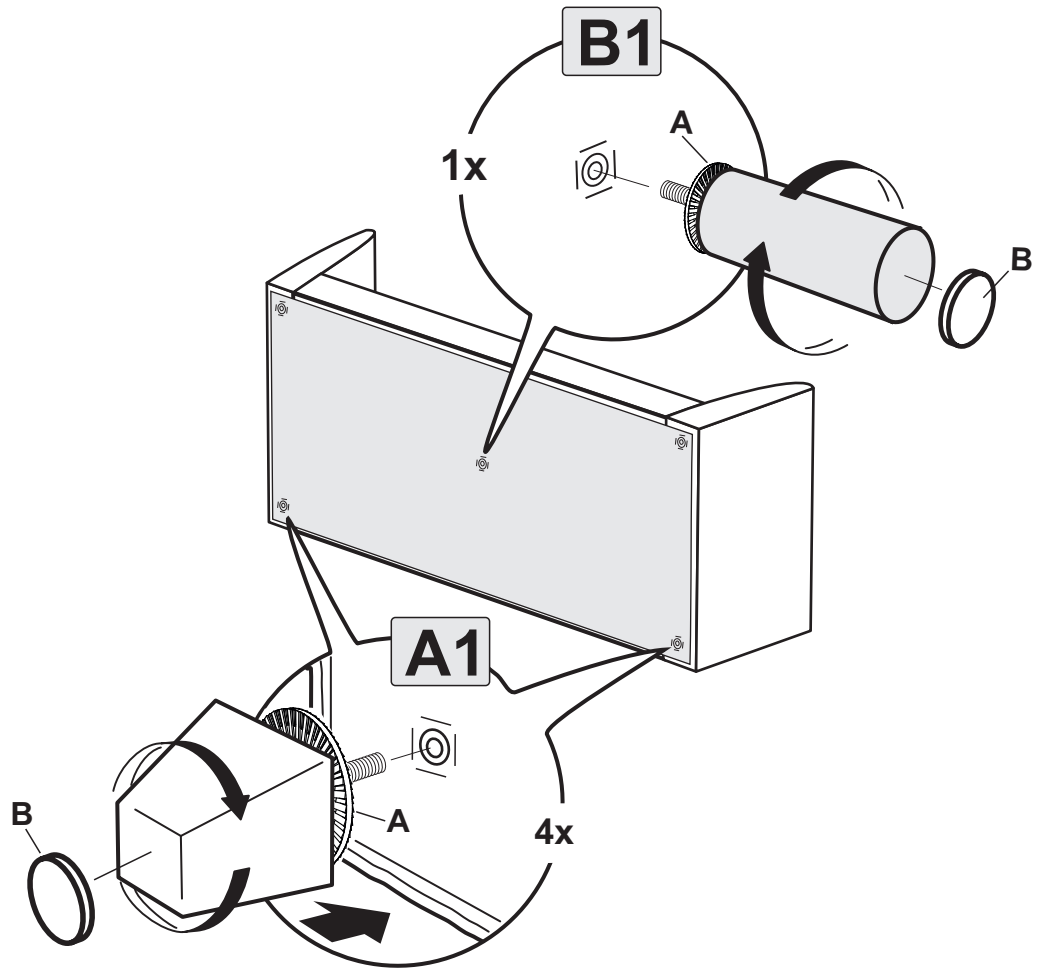
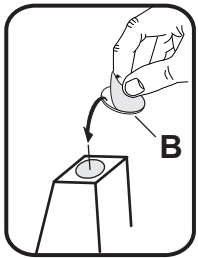

6

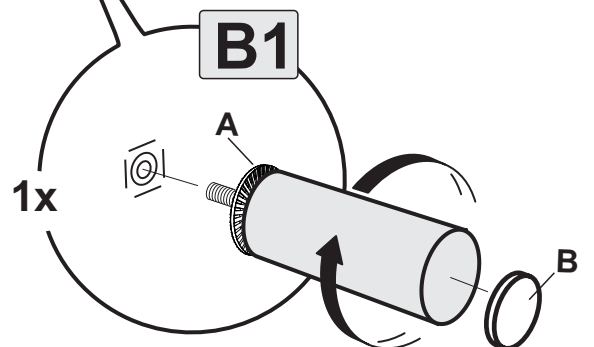
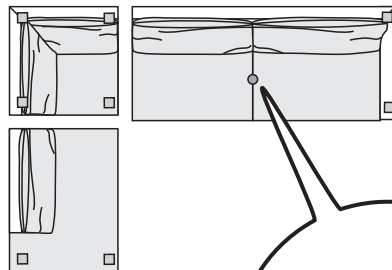
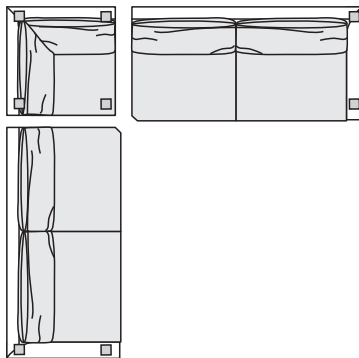
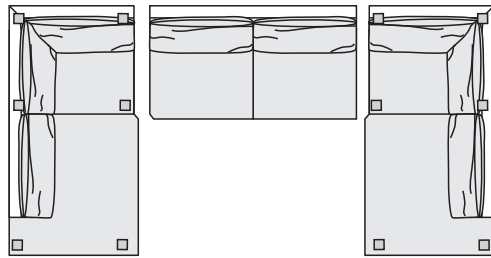
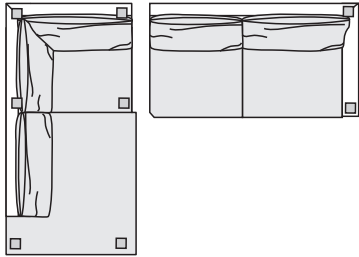

4

7

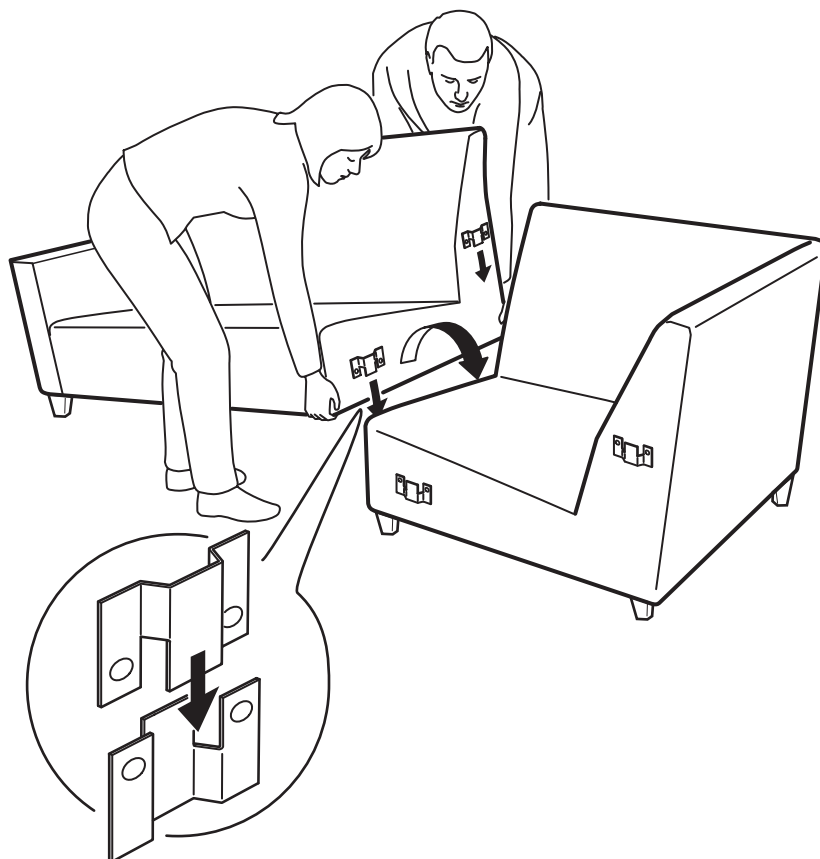

8

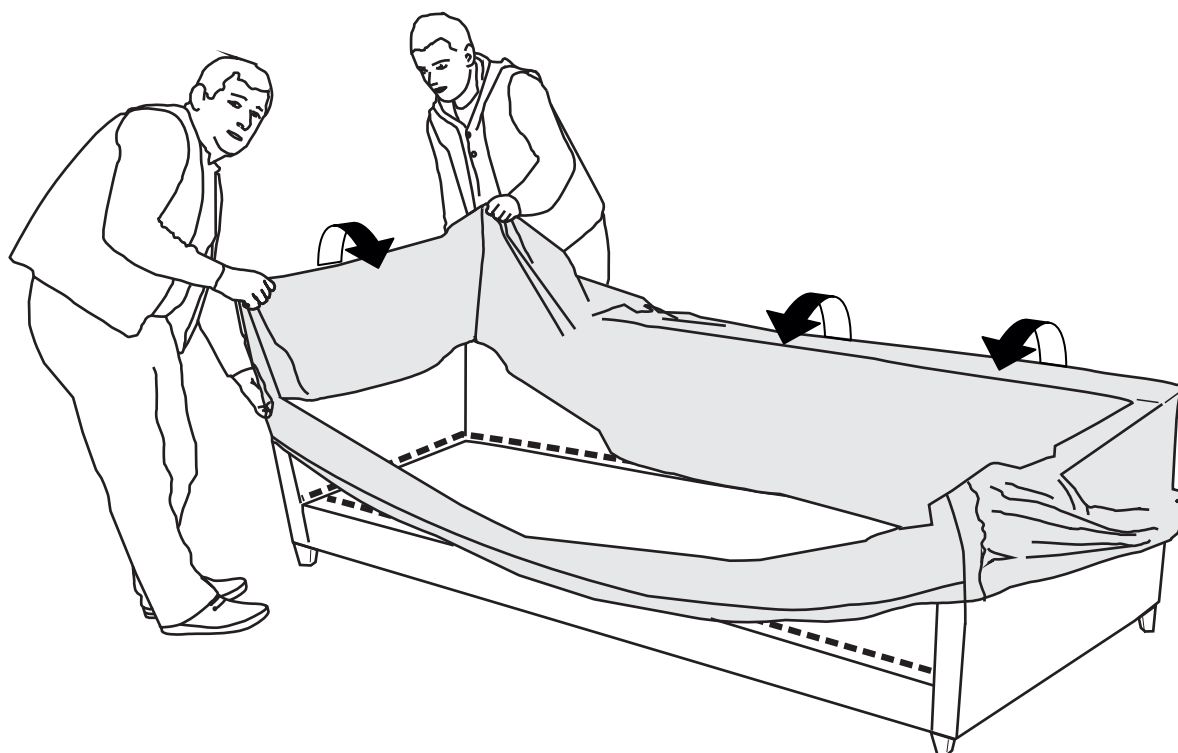

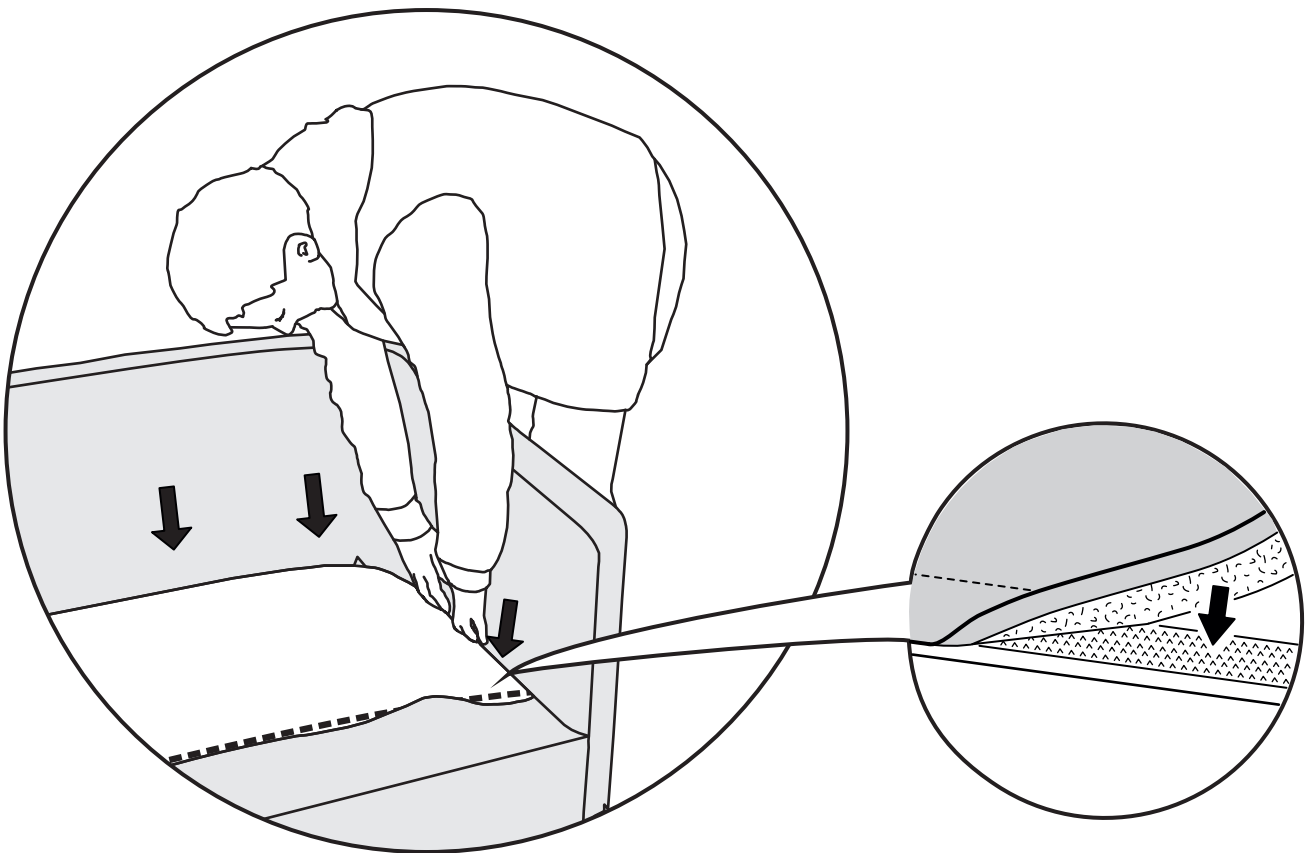
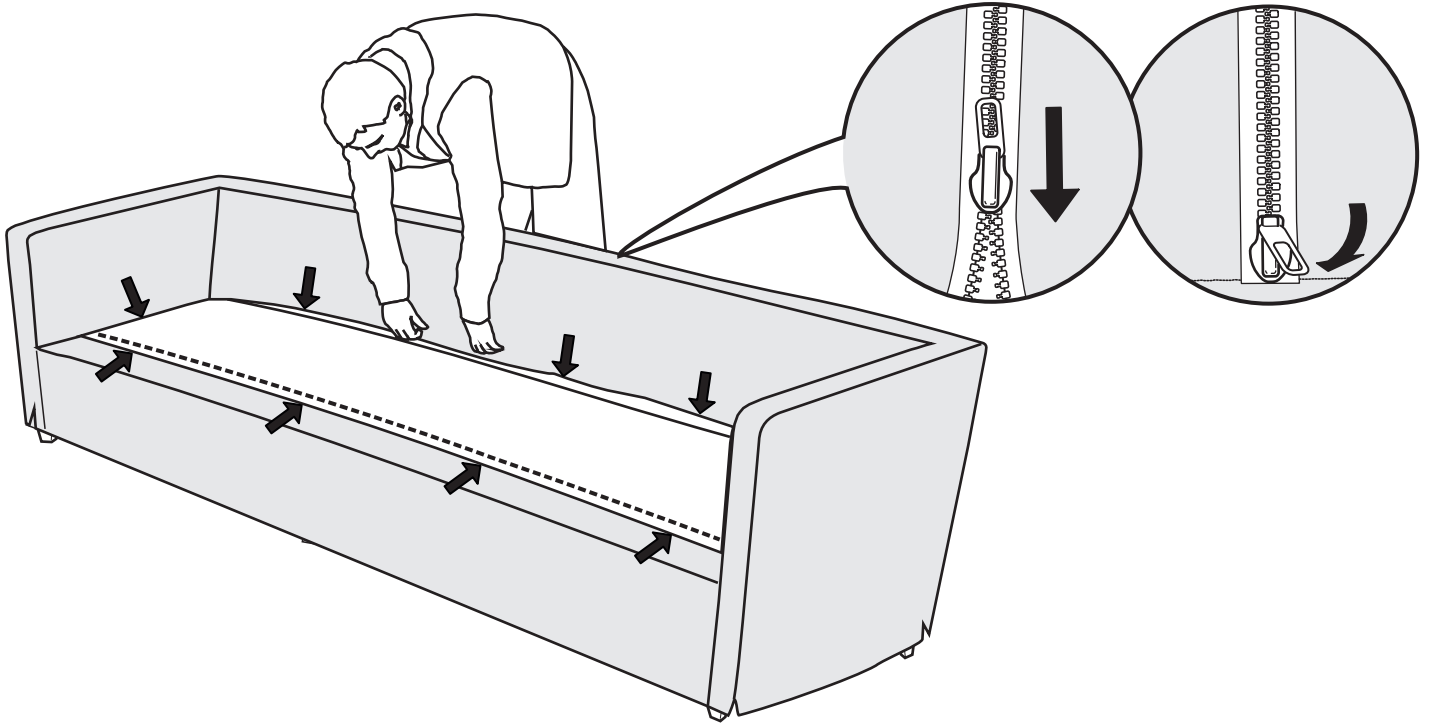

10

poszycie nr 4 / loose cover with velcro / lose Husse mit Klettband

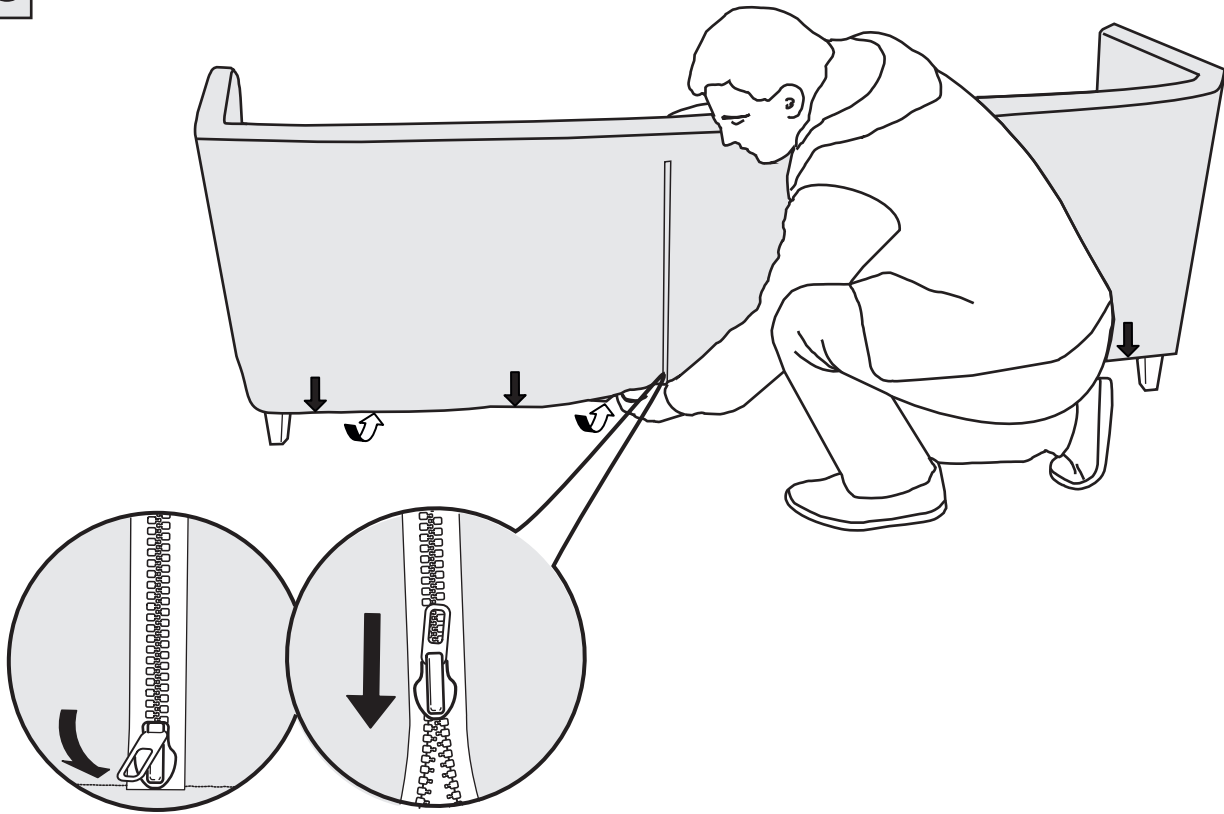

11

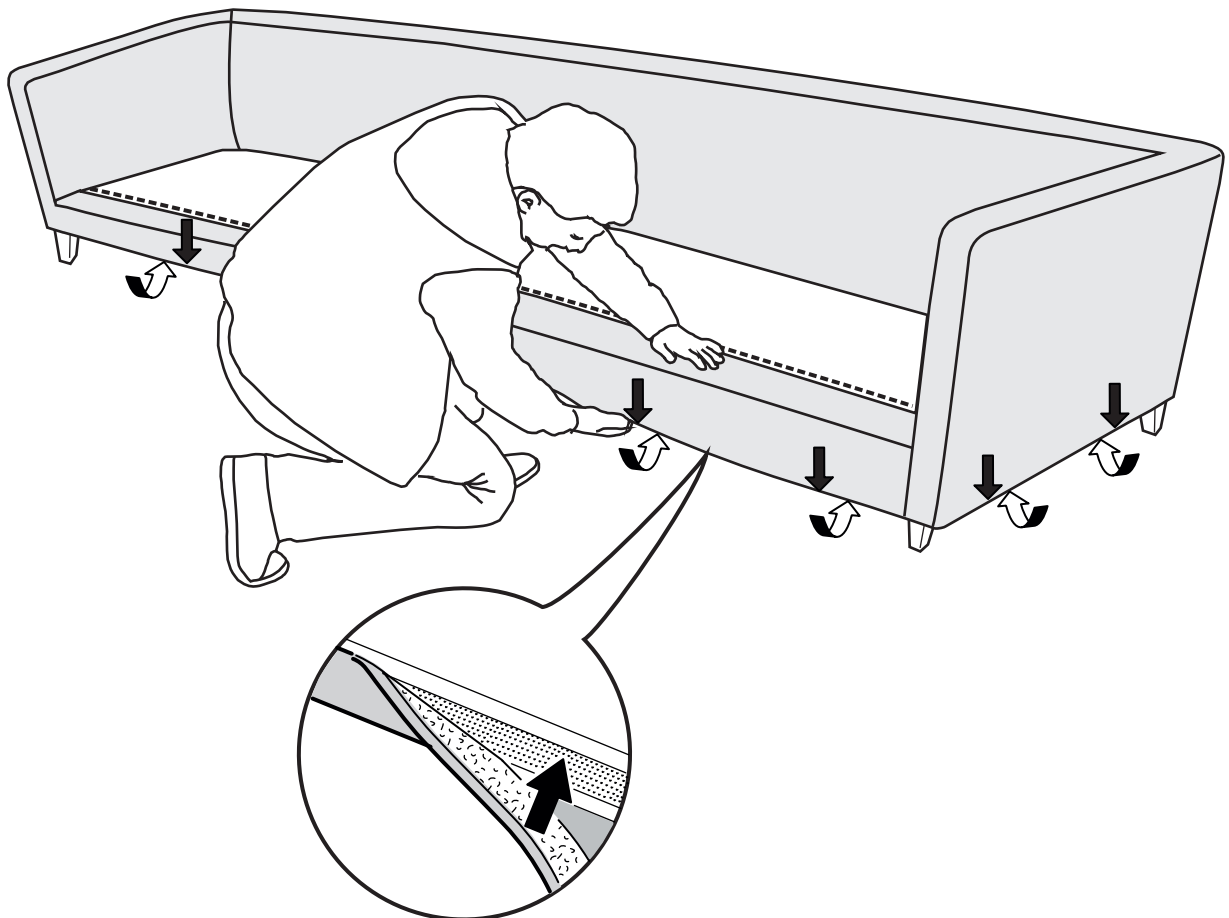

Zachowaj instrukcję / Please keep instructions / Bewahren Sie die Anleitung / Merci de garder l'instruction